

**SONODYNE**

SIC 1160 CB

ceiling speaker • owners manual

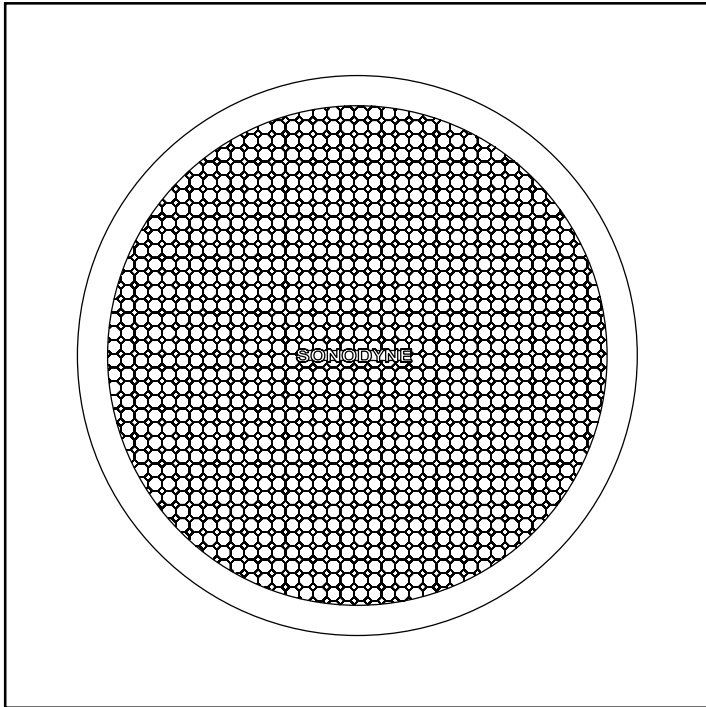

# PLACEMENT • CONNECTIONS • DIMENSIONS

Congratulations on your purchase of SIC 1160 CB ceiling speaker

Please read the owners manual carefully to ensure proper installation and performance of SIC 1160 CB





For more details please write to us at [response@sonodyne.com](mailto:response@sonodyne.com)

## PLACEMENT

Plan your speaker placement carefully. The SIC 1160 CB must be mounted in the ceiling. They should be located so that they provide even coverage at your listening position.

## CONNECTIONS

The SIC 1160 CB has 4 screw-type terminals for connecting to the amplifier output. Connect the 100V output of amp to common and any of the 3 taps. The power taps are given below. Note that if you connect 70V output, you will get half the power.

	100V	70V
YELLOW	 2.5W	1.25W
RED	 5W	2.5W
BLUE	 10W	5W
BLACK	 COM	COM

## DIMENSIONS

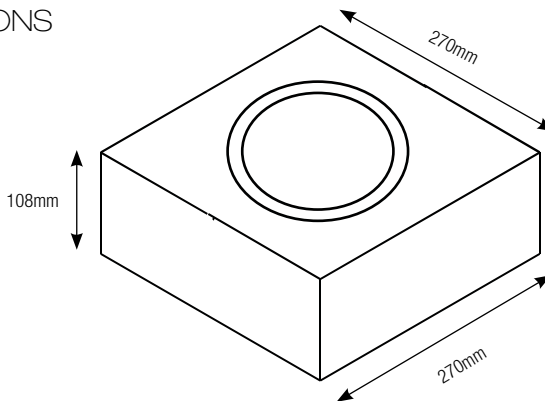

# INSTALLATION • SPECIFICATIONS

## INSTALLATION

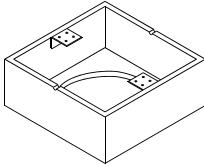

STEP-1

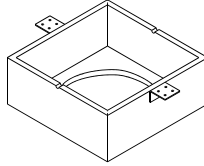

STEP-2

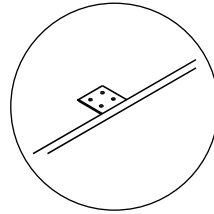

Unscrew and fit the bracket facing the other side

## SPECIFICATIONS

DESCRIPTION	2 way in-ceiling speaker
TRANSDUCER	1 x 6" coaxial speaker
FREQUENCY RANGE (-10dB)	80Hz ~ 18kHz
FREQUENCY RESPONSE (-3dB)	70Hz ~ 20kHz
SENSITIVITY 1W/1M	88dB (half space)
SPL AT RATED POWER	98dB @ 10W
NOMINAL IMPEDANCE	8Ω
POWER HANDLING DIRECT MODE	20W
POWER TAPS	
100V	2.5W, 5W, 10W
70V	1.25W, 2.5W, 5W
OUTER DIMENSIONS	82mm x 228mm (depth x diameter)
WOODEN BOX DIMENSIONS HxWxD	108mm x 270mm x 270mm
COLOUR	White/ Black
MOUNTING	Ceiling mount
GROSS WEIGHT	1.9kg

*NOTE: Due to continuous improvements, all specifications are subject to change*

Register your product  
to activate your warranty:  
<https://sonodyne.com/registerproduct>



Upload a picture or video of your Sonodyne  
product or write about your Sonodyne  
experience.  
<https://sonodyne.com/review>

If you have anything less than a 5 star experience,  
please contact us at [response@sonodyne.com](mailto:response@sonodyne.com)  
and we will make it right

# SONODYNE

SONODYNE, India • H.O.: 98 NB Block E New Alipore, Kolkata 700053

 sonodyneofficial

 +91 9830855260

 SonodyneMusic

 [response@sonodyne.com](mailto:response@sonodyne.com)

 sonodyneofficial

 [www.sonodyne.com](http://www.sonodyne.com)